

**Report
Of
Accessibility Audit of the Incubation center
and Criminology Newly Constructed Building
at the University of Peshawar**



HEAD OFFICE

Friends of Paraplegics , Street 10, Sector P1,
Phase 4, Hayatabad, Peshawar,
Pakistan



Report Overview

On the day of 09th of November, 2021, FoP Collaboratory with Community services Program (CSP) conducted Accessibility Audit of the Newly Constructed Building at the University of Peshawar, Khyber Pakhtunkhwa. The Audit convened academicians, University of Peshawar administration, media, and Friends of Paraplegics team. The Accessibility Audit Surged University of Peshawar on the Higher Education of Pakistan (HEC)'s policy for Students with Disability 2021 which aims to create an enabling environment Education Sector to not only motivate students with disabilities to undertake higher education, but also facilitates their participation in all academic and extra-curricular aspects of a university education. Accessibility checks of the IC and criminology department building and identify the spots where they can improve access and maximum participation of PwDs students. On this occasion, Professor Dr. Muhammad Idrees, Vice Chancellor, University of Peshawar, Project Director Prof. Dr. Yorid Ahsan Zia, Dr. Shakeel Ahmed, Director, Community Service Program, Dr. Imran Ahmad Sajid, Focal Person of the MoU, Engineer Shakeel Works Department and other experts of the Friends of Paraplegics were present. At the end, the Audit team has provided their recommendations for improvement and accessibility of the buildings.

LIST OF ABBREVIATIONS

CSP	Community Service Program
FOP	Friends of Paraplegics
HEC	Higher Education Commission
IC	Incubation Center
UoP	University of Peshawar

Table of Contents

Report Overview	2
List of Abbreviations	3
Table of Contents	4
Introduction and Background	5
Audit Objectives	6
Audit Participants	6
Anticipated Results/Recommendations	7
Accessible Washroom Plan	8
Criminology Building report	9
Pictures During Accessibility Audit	10
Proposed Designs for Shaikh Taimoor Academic Block	11
Annexure	14

Introduction and Background

The University of Peshawar, Department of Social Work and Community Service Program, University of Peshawar had inked a MoU with Friends for paraplegics, Peshawar in a ceremony held on Oct 14th 2021. The purpose of the MoU was to make collaborative efforts for making University of Peshawar as Model accessible University for Persons with Disabilities as per the policy of Higher Education Commission (HEC), Pakistan and UN Convention of the Rights of Person with Disability. Under this MoU, it was signed that courses on special education and rehabilitation will be designed for producing a trained human resource to work in the policy making institutes for promoting the rights of PWD. Under, this MoU it was also signed that effort will be made to hold an International Conference on Accessibility and Rights of Persons with Disability in 2022.

In this regard, team of experts of the Friends of Paraplegics (FoP) Peshawar, headed by Engineer Irfan (GS FoP) has conducted Accessibility Audit of the Newly Constructed Building of the Department of Criminology and Incubation Centre University of Peshawar. FoP is the partner of the Community Service Program (CSP), University of Peshawar and Department of Social Work, University of Peshawar bonded under MoU 2021. Under the MoU, the partner organizations have to take all possible measures to make the University of Peshawar as Disable-Friendly Institute in Khyber Pakhtunkhwa. Furthermore, the already constructed building of the Sheikh Taimur Academic Block-1 was also audited and found accessibility for the students with disability but that was not as per International standards. The ramps at the entrance and exit of the building were recommended to be improved with in the limited resources soon as Model Step for the rest of the buildings of the UoP.

Participants

- Prof. Dr. Muhammad Idrees, Vice Chancellor, University of Peshawar,
- Prof. Dr. Yorid Ahsan Zia, Project Director
- Dr. Shakeel Ahmed, Director, Community Service Program,
- Dr. Imran Ahmad Sajid, Focal Person of the MoU,
- Engineer Shakeel Works Department
- Engineer Irfan Ullah, General Secretary, Friends of Paraplegics
- Engineer Muhammad Imran, Civil Engineer, Friends of Paraplegics and other experts of the Friends of Paraplegic

Audit Objectives

- Accessibility checks of the IC and criminology department building and identify the spots where they can improve access and maximum participation of PwDs students.
- To find out the accessible spots of the Newly Constructed Building at the University of Peshawar.
- To provide recommendations for aligning the buildings according to the need of Persons with Disabilities.
- To create an enabling environment Education Sector to not only motivate students with disabilities to undertake higher education, but also facilitates their participation in all academic and extra-curricular aspects of a university education.

The Audit has revealed the following results:

Incubation center

- Incubation center ramp height was 56 inch and run were 45 feet which were less than 1 ratio 12 but it's acceptable, as per standard it was required 57.6 feet.
- Stay after the ramp of IC was not up to the standard and we recommended to increase that stay up to 6feet to avoid injury.
- Grab bar in washroom of IC were missing which is important for sever students and staff with disabilities.
- The mirror height were more than 3 feet and recommended to decrease its size so wheelchair user will be able to use it.
- Height of the toilet and turning area was good and they have 1 reserve washroom for PwDs.
- Basement ramp was very good but handrails were missing in this ramp
- Sitting area were also not accessible and recommended to make it accessible and give entrance for wheelchair user in the basement center area and ground in front of the IC department lawns.
- No reserve parking was found and no signage were in the parking for reserve parking
- Washbasin was also not accessible and the clear area length for good but feet were not as per standard of 18 inch and in basin lever handle were recommended
- Door swings were on both sides which was good
- Elevator will be installed in the IC department and 1st floor will be accessible through that elevator.
- Brail track for visual impaired were missing which will be installed
- Signage for hearing impaired were missing which were recommended
- Rooms were fully accessible for PwDs
- Height of the buttons in the building were fully accessible
- Floor was overall plan and were accessible for pwds
- Door entrance were accessible for pwds
- Windows were accessible and in reach of wheelchair users
- Stage in the IC building was removable and they will make removable ramp will be used for stage accessibility

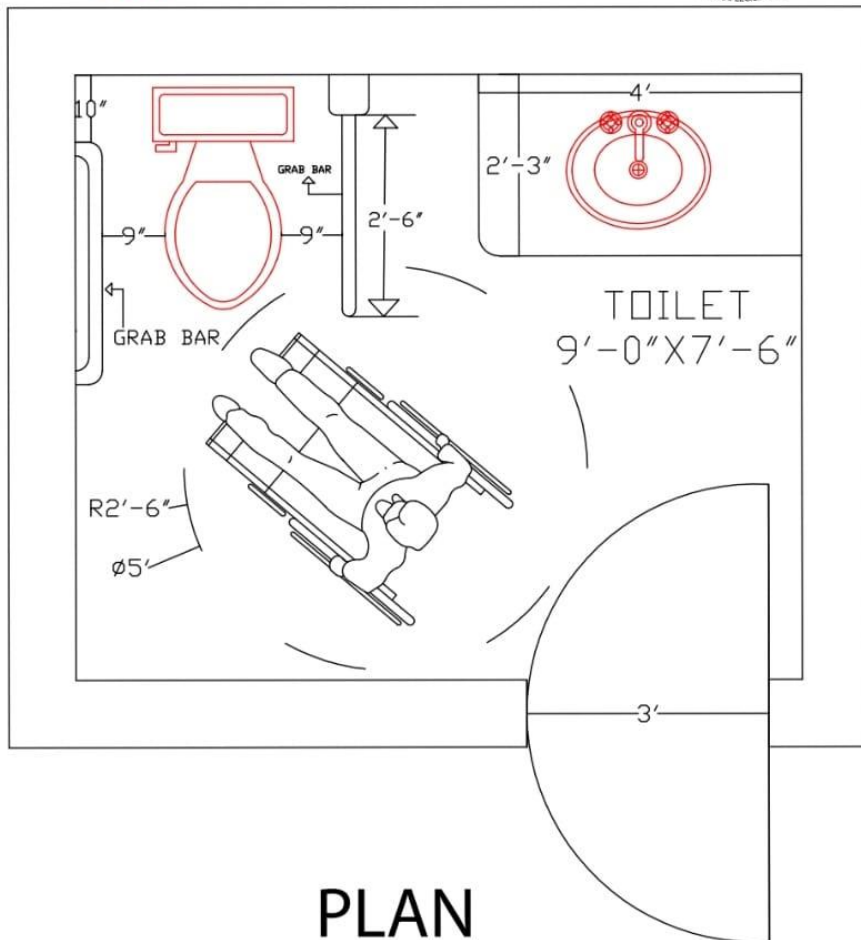

Figure 1.1. Accessible Washroom Measurement

As part of the discussion with Vice Chancellor regarding the Incubation Center, the concerns concerning the PwDs reservations were chalked out. In response to the raised concerns the VC assured to cater for the space for Persons with Disabilities which will pave the way for bringing novel ideas, developing linkages and launching entrepreneurship in its domain. The both parties come to the contentment to start work on it soon in recent future.

Anticipated Audit Results/Recommendations

The Audit has revealed the following results:

Criminology Building Report

- Ramp height was 50 inch and length was 43 feet and it was less than the standard of 1 ratio 12, it was required 50.4 but its run is 43 feet with the ratio of 10.23 which is less than 1 ratio 12 but it acceptable
- In criminology new building the washrooms were not accessible and the door width was also not accessible and its width was 2.2inch, total 30inch clear area will be required for a wheelchair users
- Washrooms were in common rooms and they were not accessible
- Classes were accessible with even surface
- Permanent Stage of the criminology building was not accessible, Ramp for stage was recommended which was missing
- standard for washrooms is shared to make the washrooms accessible for PwDs
- Washroom doors were less than 3 feet and they were not accessible for wheelchair users, Grip bars were missing in washrooms
- Mirror height of washroom was above 3 feet which was not in reach of wheelchair users
- Wash basin was also not accessible just like Incubation center building clear area for feet were less than 18 inch and in basin lever handle were recommended
- Basement and 1st floor were accessible through elevator and elevator were not installed in the criminology new building

Accessibility Audit of IC & Criminology Department



Image 1.1. Measurement of Ramp walk



Proposed Designs for Shaikh Taimoor Academic Block-06

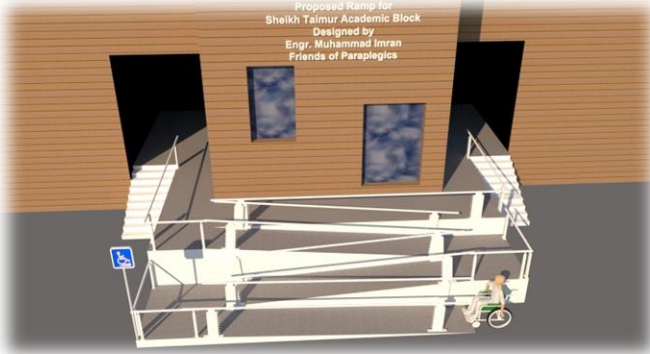

Proposal 1 Front View



Proposal 1 one side view

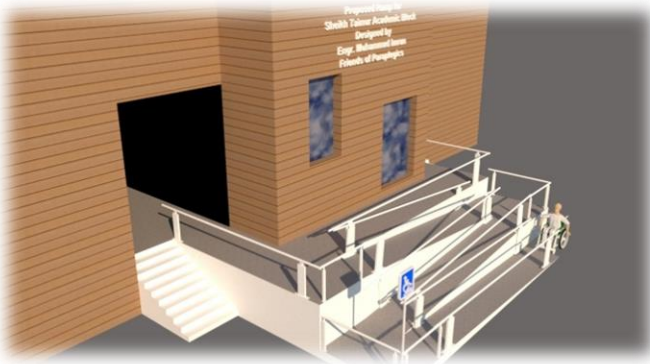

Proposal 1 top left View



Proposal 1 close View



Proposal 2 Complete view



Proposal 2 right View



Proposal 2 entrance View

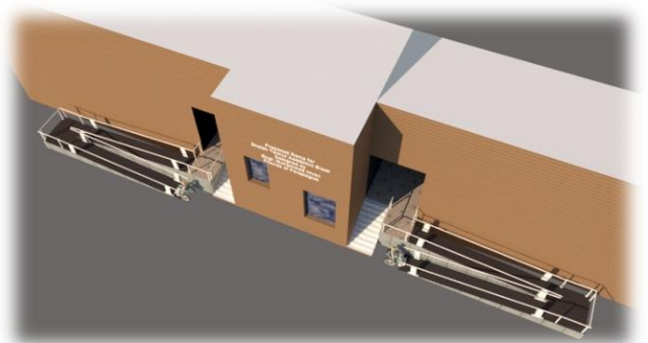

Proposal 2 top View



Proposal 2 intermediate View



Proposal 2 Front View

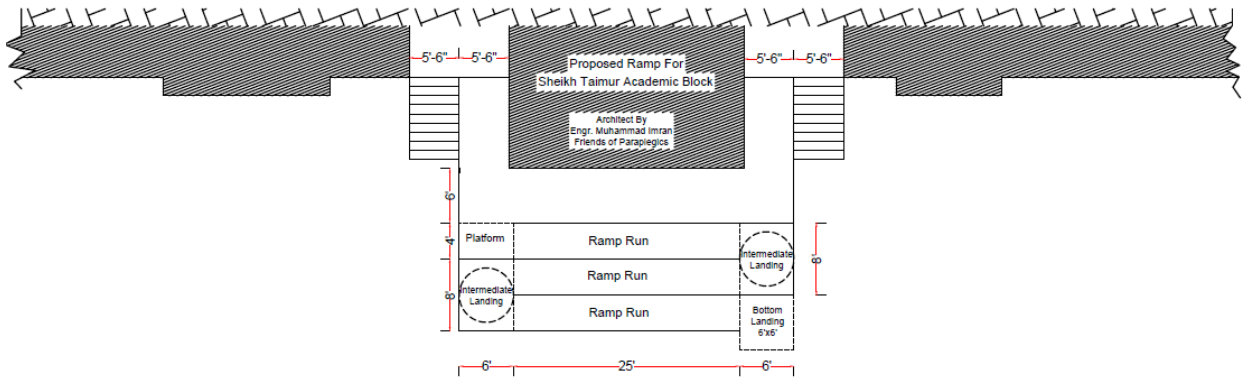

Proposal 1

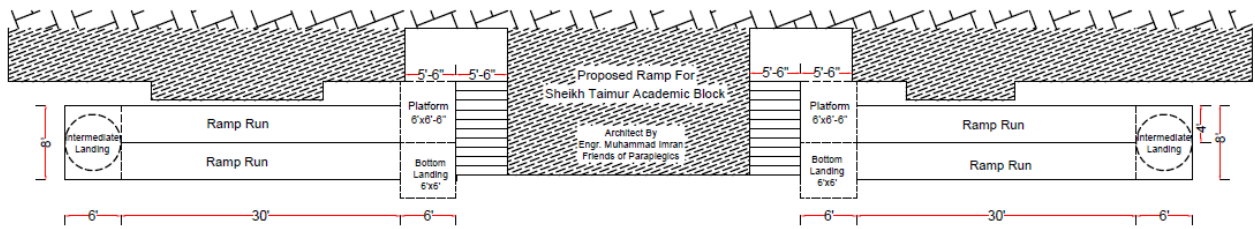

Proposal 2

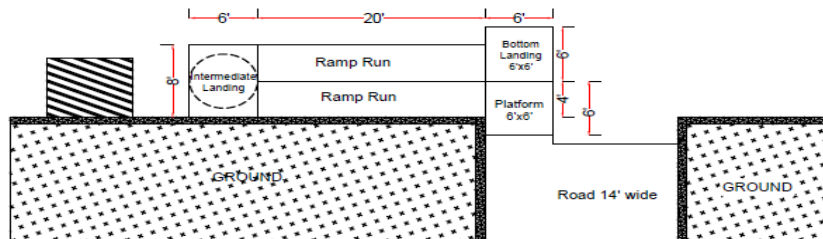

Proposed Ramp of Main Entrance at Sheikh Taimur Academic Block

Proposed ramp for entrance ramp from car Parking

Annexes

Image 1.2. Discussion with Vice Chancellor and concerned personals

Report composed by:	Name: Bilal Bahadar, Content Developer Noman Khan Afridi, Assist. Content Developer Organization: Friends of Paraplegics (FoP)
Designed by	Name: Engr Muhammad Imran Civil Engineer Organization: Friends of Paraplegics (FoP)
Sign Offs:	Engr. Irfan Ullah (General Secretary) (FoP)